

R package: 1200V 100A IGBT module

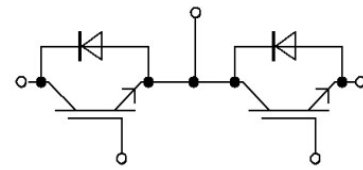

Equivalent Circuit Schematic

Features:

- 1200V 100A, $V_{CE(sat)} = 2.50V$
- planar field-stop technology
- High RBSOA capability
- Low turn-off losses

产品特性:

- 1200V 100A, $V_{CE(sat)} = 2.50V$
- 平面栅场终止技术
- 高 RBSOA 性能
- 低关断损耗

Typical Applications:

- Inductive Heating
- Welding
- High Frequency Switching Application

典型应用:

- 感应加热
- 电焊机
- 高频开关应用

IGBT, Inverter / IGBT, 逆变部分

Maximum Rated Values / 最大标称参数

Collector-emitter Voltage 集电极-发射极电压	$T_{vj}=25^{\circ}\text{C}$	V_{CES}	1200	V
Continuous DC collector current 集电极连续直流电流		$I_{C\text{ nom}}$	100	A
	$T_C=80^{\circ}\text{C}, T_{vj\text{ max}}=150^{\circ}\text{C}$	I_C	107	A
Repetitive Peak collector current 集电极可重复峰值电流	$I_{CRM}=2 \times I_{C\text{ nom}}$	I_{CRM}	200	A
Total power dissipation 总功率损耗	$T_C=25^{\circ}\text{C}, T_{vj\text{ max}}=150^{\circ}\text{C}$	P_{tot}	565	W
Gate-emitter peak voltage 门极-发射极峰值电压		V_{GES}	± 20	V

Characteristic Values / 性能参数

			min.	typ.	max.	
Collector-emitter saturation Voltage 集电极-发射极饱和压降	$I_C=100\text{A}, V_{GE}=15\text{V}, T_{vj}=25^{\circ}\text{C}$ $I_C=100\text{A}, V_{GE}=15\text{V}, T_{vj}=125^{\circ}\text{C}$ $I_C=100\text{A}, V_{GE}=15\text{V}, T_{vj}=150^{\circ}\text{C}$	V_{CESat}		2.50 3.00 3.10	3.10	V
Gate Threshold Voltage 门极阈值电压	$V_{CE}=V_{GE}, I_C=1\text{mA}, T_{vj}=25^{\circ}\text{C}$	V_{GEth}	5.0	6.0	7.0	V
Gate Charge 门极电荷	$V_{GE} = -15\text{V} \dots +15\text{V}$	Q_G		0.70		μC
Internal Gate Resistor 内置门极电阻	$T_{vj}=25^{\circ}\text{C}$	R_{Gint}		5		Ω
Input Capacitance 输入电容	$V_{CE} = 25\text{V}, V_{GE} = 0\text{V}$ $f = 1\text{MHz}$	C_{ies}		4.38		nF
Reverse Transfer Capacitance 反向传输电容		C_{res}		0.20		nF
Collector-emitter Cutoff Current 集电极-发射极关断漏电流	$V_{CE}=1200\text{V}, V_{GE}=0\text{V}, T_{vj}=25^{\circ}\text{C}$	I_{CES}			1	mA
Gate-emitter Leakage Current 门极-发射极漏电流	$V_{CE}=0\text{V}, V_{GE}=\pm 20\text{V}, T_{vj}=25^{\circ}\text{C}$	I_{GES}			± 200	nA
Turn-on Delay Time, Inductive Load 开通延迟时间, 感性负载	$I_C=100\text{A}, V_{CE}=600\text{V}, T_{vj}=25^{\circ}\text{C}$ $V_{GE}=\pm 15\text{V}, T_{vj}=125^{\circ}\text{C}$ $R_{Gon}=4.7\Omega, T_{vj}=150^{\circ}\text{C}$	t_{don}		57 58 60		ns
Rise Time, Inductive Load 上升时间, 感性负载	$I_C=100\text{A}, V_{CE}=600\text{V}, T_{vj}=25^{\circ}\text{C}$ $V_{GE}=\pm 15\text{V}, T_{vj}=125^{\circ}\text{C}$ $R_{Gon}=4.7\Omega, T_{vj}=150^{\circ}\text{C}$	t_r		43 50 50		ns
Turn-off Delay Time, Inductive Load 关断延迟时间, 感性负载	$I_C=100\text{A}, V_{CE}=600\text{V}, T_{vj}=25^{\circ}\text{C}$ $V_{GE}=\pm 15\text{V}, T_{vj}=125^{\circ}\text{C}$ $R_{Goff}=15\Omega, T_{vj}=150^{\circ}\text{C}$	t_{doff}		350 410 410		ns
Fall Time, Inductive Load 下降时间, 感性负载	$I_C=100\text{A}, V_{CE}=600\text{V}, T_{vj}=25^{\circ}\text{C}$ $V_{GE}=\pm 15\text{V}, T_{vj}=125^{\circ}\text{C}$ $R_{Goff}=15\Omega, T_{vj}=150^{\circ}\text{C}$	t_f		22 30 35		ns
Turn-on energy loss per pulse 开通损耗	$I_C=100\text{A}, V_{CE}=600\text{V}, T_{vj}=25^{\circ}\text{C}$ $L_{\sigma}=80\text{nH}, V_{GE}=\pm 15\text{V}, T_{vj}=125^{\circ}\text{C}$ $R_{Gon}=4.7\Omega, T_{vj}=150^{\circ}\text{C}$	E_{on}		8.80 12.80 13.80		mJ
Turn-off energy loss per pulse 关断损耗	$I_C=100\text{A}, V_{CE}=600\text{V}, T_{vj}=25^{\circ}\text{C}$ $L_{\sigma}=80\text{nH}, V_{GE}=\pm 15\text{V}, T_{vj}=125^{\circ}\text{C}$ $R_{Goff}=15\Omega, T_{vj}=150^{\circ}\text{C}$	E_{off}		2.70 4.20 5.30		mJ

Thermal Resistance, Junction to Case 结-壳热阻	Per IGBT/单个 IGBT	R_{thJC}		0.22		K/W
Temperature under switching conditions 工作温度		$T_{vj\ op}$	-40		150	°C

Diode, Inverter / 二极管, 逆变部分

Maximum Rated Values / 最大标称参数

Repetitive peak reverse voltage 可重复反向峰值电压	$T_{vj}=25^{\circ}C$	V_{RRM}		1200		V
Continuous DC Forward Current 可连续正向直流电流		I_F		100		A
Repetitive Peak Forward Current 可重复正向峰值电流	$I_{CRM}=2 \times I_{Fnom}$	I_{FRM}		200		A

Characteristic Values / 性能参数

			min.	typ.	max.	
Forward Voltage 正向通态压降	$I_F=100A, V_{GE}=0V$ $I_F=100A, V_{GE}=0V$ $I_F=100A, V_{GE}=0V$	$T_{vj}=25^{\circ}C$ $T_{vj}=125^{\circ}C$ $T_{vj}=150^{\circ}C$	V_F	2.40 2.50 2.50	2.90	V
Peak Reverse Recovery Current 反向恢复峰值电流	$I_F=100A, V_R=600V$ $-di_F/dt=2580A/us$ $V_{GE}=-15V$	$T_{vj}=25^{\circ}C$ $T_{vj}=125^{\circ}C$ $T_{vj}=150^{\circ}C$	I_{RM}	55 55 55		A
Recovery Charge 反向恢复电荷	$I_F=100A, V_R=600V$ $-di_F/dt=2580A/us$ $V_{GE}=-15V$	$T_{vj}=25^{\circ}C$ $T_{vj}=125^{\circ}C$ $T_{vj}=150^{\circ}C$	Q_R	3.50 7.50 9.00		μC
Reverse Recovery Energy 反向恢复损耗	$I_F=100A, V_R=600V$ $-di_F/dt=2580A/us$ $V_{GE}=-15V$	$T_{vj}=25^{\circ}C$ $T_{vj}=125^{\circ}C$ $T_{vj}=150^{\circ}C$	E_{rec}	2.50 4.20 4.80		mJ
Thermal Resistance, Junction to Case 结-壳热阻	Per Diode / 单个 Diode	R_{thJC}		0.50		K/W
Temperature under switching conditions 工作温度		$T_{vj\ op}$	-40		150	°C

Module / 模块

Isolation Test Voltage 绝缘测试电压	RMS, f=50Hz, t=1min	V _{ISOL}	3.0	KV
Material of Module Baseplate 模块底板材料			Cu	
Internal Isolation 内部绝缘	基本绝缘 (class 1, IEC 61140) Basic insulation (class1,IEC 61140)		Al ₂ O ₃	
Creepage Distance 爬电距离	端子-散热片 terminal to heatsink 端子-端子 terminal to terminal		17.0 20.0	mm
Clearance 电气间隙	端子-散热片 terminal to heatsink 端子-端子 terminal to terminal		17.0 9.5	mm
Comparative Tracking Index 相对漏电起痕指数		CTI	>200	

min. typ. max.

Thermal resistance, case to heatsink 外壳-散热器热阻	每个模块/per module $\lambda_{\text{Paste}} = 1W/(m \cdot K) / \lambda_{\text{grease}} = 1W/(m \cdot K)$	R _{thCH}		0.05		K/W
Stray Inductance Module 模块杂散电感		L _{sCE}		30		nH
Module Lead Resistance, Terminals-Chip 模块引脚电阻, 端子-芯片	T _C =25°C,每个开关 per switch	R _{CC'+EE''}		0.65		mΩ
Storage Temperature 贮存温度		T _{stg}	-40		125	°C
Modul Mounting torque 模块安装扭距	M6	M	3.0		5.0	Nm
Terminal Mounting torque 端子安装扭距	M5	M	2.5		6.0	Nm
Weight 重量		G		145		g

输出特性 IGBT, 逆变器(典型值)
Output characteristic IGBT Inverter (typical)
 $I_C = f(V_{CE})$,
 $V_{GE} = 15V$

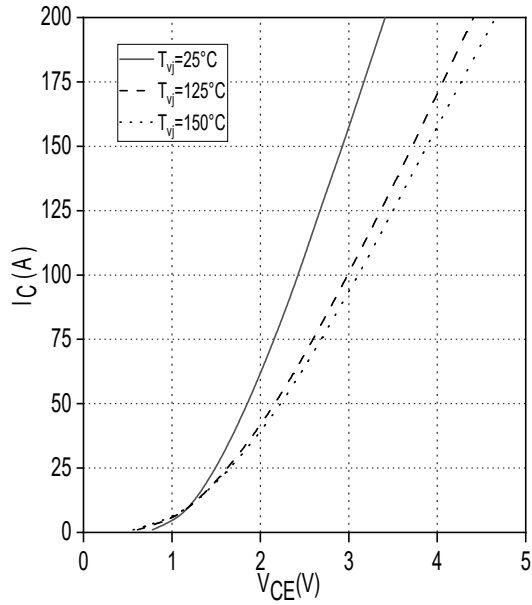

输出特性 IGBT, 逆变器(典型值)
output characteristic IGBT Inverter (typical)
 $I_C = f(V_{CE})$,
 $T_{vj} = 150^{\circ}C$

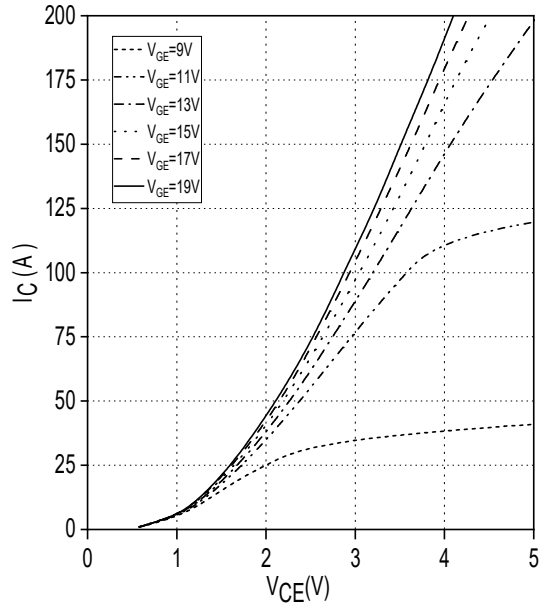

传输特性 IGBT, 逆变器 (典型值)
Transfer characteristic IGBT, Inverter (typical)
 $I_C = f(V_{GE})$,
 $V_{CE} = 20V$

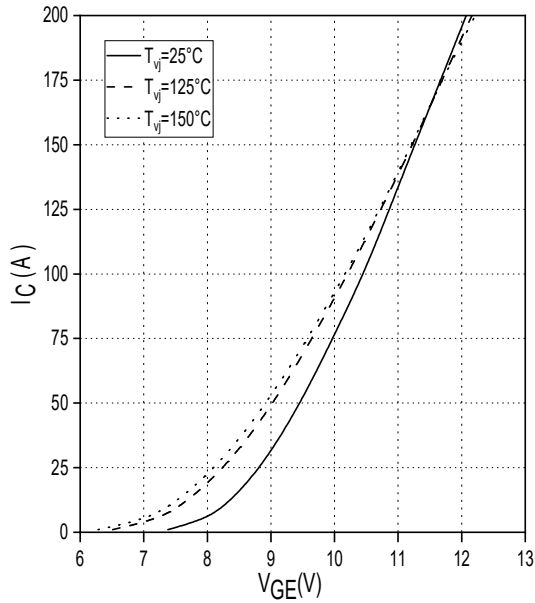

开关损耗 IGBT, 逆变器 (典型值)
switching losses IGBT, Inverter (typical)
 $E_{on} = f(I_C), E_{off} = f(I_C), V_{GE} = \pm 15V$,
 $R_{Gon} = 4.7\Omega, R_{Goff} = 15\Omega, V_{CE} = 600V$

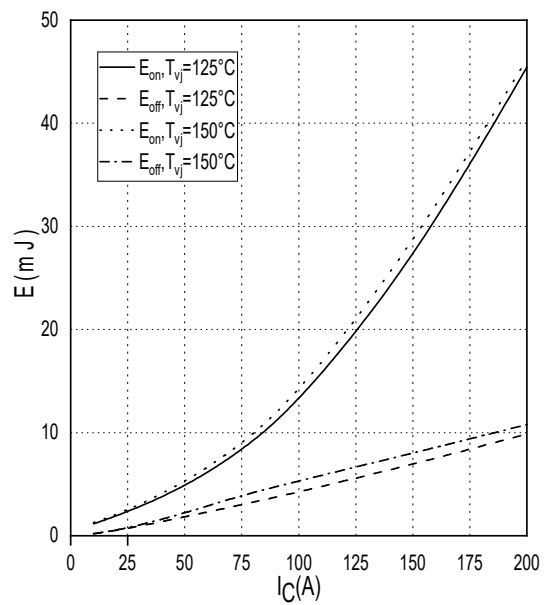

开关损耗 IGBT, 逆变器 (典型值)
Switching losses IGBT, Inverter (typical)
 $V_{GE} = \pm 15V, I_C = 100A, V_{CE} = 600V$

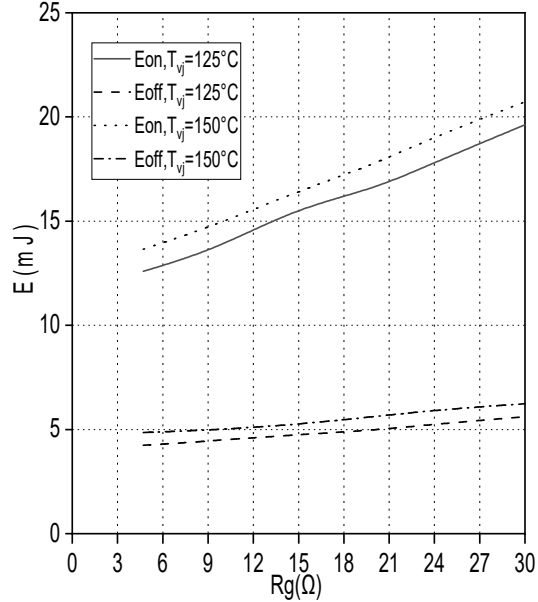

瞬态热阻抗 IGBT, 逆变器
transient thermal impedance IGBT, Inverter
 $Z_{thJC} = f(t)$

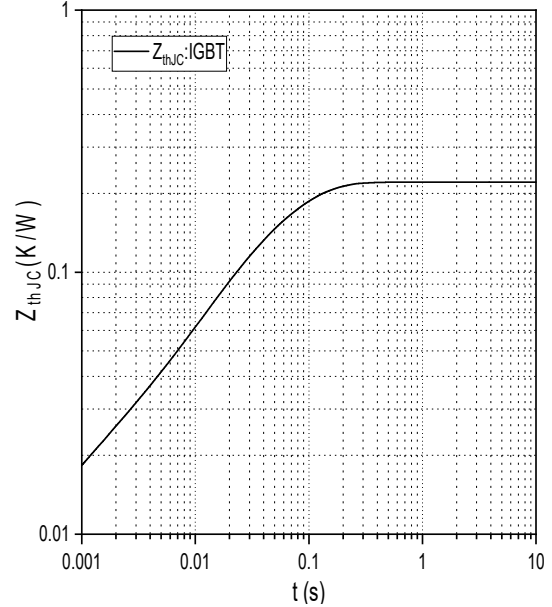

反偏安全工作区 IGBT, 逆变器 (RBSOA)
Reverse bias safe operating area IGBT, Inverter (RBSOA) $I_C = f(V_{CE})$
 $V_{GE} = \pm 15V, R_{Goff} = 15\Omega, T_{vj} = 150^\circ C$

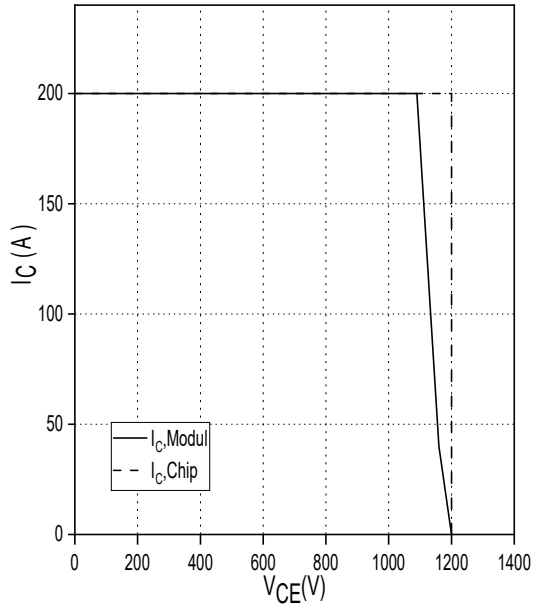

正向偏压特性二极管, 逆变器 (典型值)
forward characteristic of Diode, Inverter (typical)
 $I_F = f(V_F)$

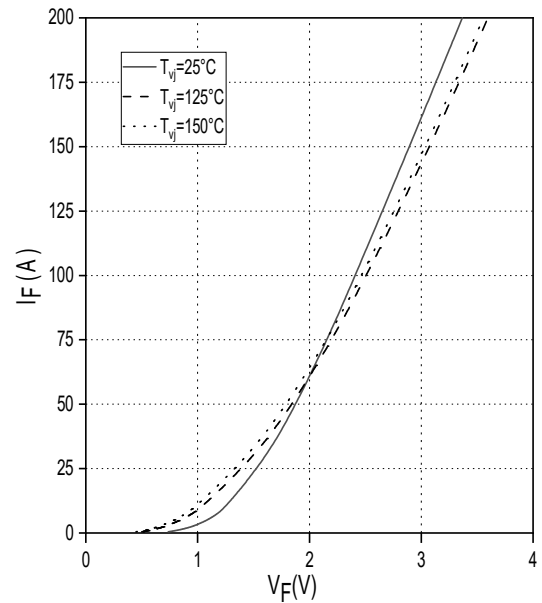

开关损耗二极管,逆变器 开关损耗 (典型值)

Switching losses Diode, Inverter (typical)

$E_{rec} = f(I_F)$

$R_{Gon} = 4.7\Omega, V_{CE} = 600V$

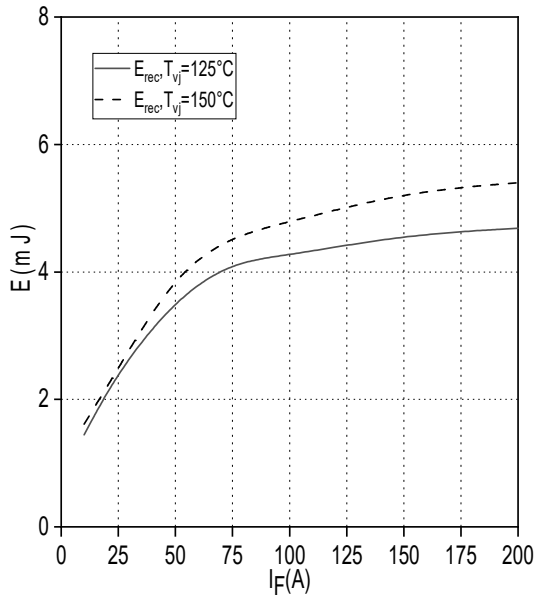

二极管,逆变器 (典型值)

switching losses Diode, Inverter (typical)

$E_{rec} = f(R_G)$

$I_F = 100A, V_{CE} = 600V$

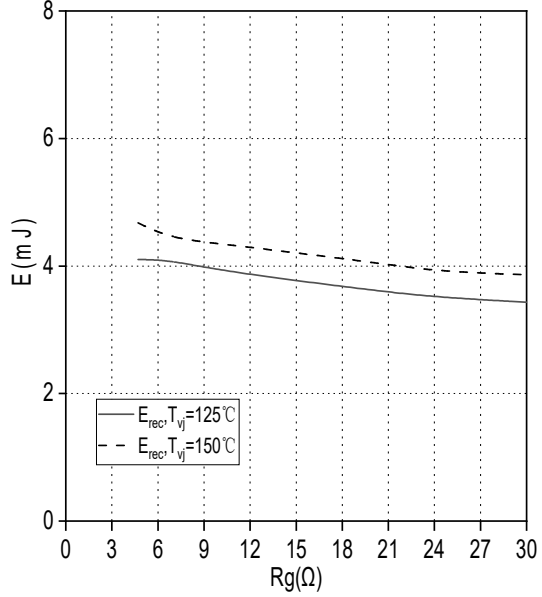

瞬态热阻抗二极管,逆变器

transient thermal impedance Diode, Inverter

$Z_{thJC} = f(t)$

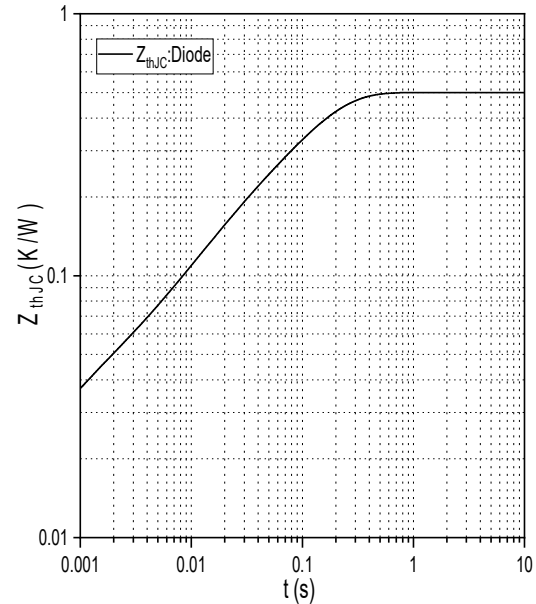

Internal Circuit:

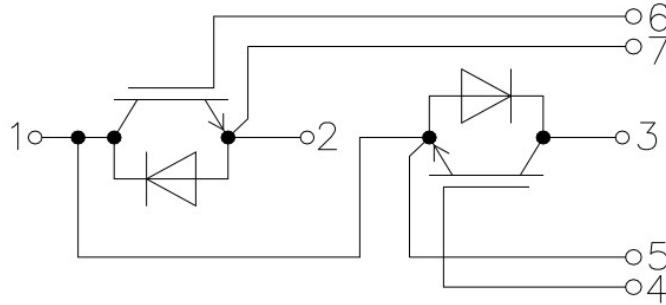

**Package Dimension
Dimensions in Millimeters**

